



PROTECT AGAINST
FIRE WHILE
OPTIMISING YOUR
STORAGE

Fire files

FIRE-RESISTANT DOCUMENT PROTECTION

Safeguarding your most important paperwork from fire

Today's organisations understand that their important paperwork, such as accounting information, contracts, certificates and other sensitive documents, is critical to business continuity and simply cannot be lost or destroyed. But in many offices, storage space for this type of files is difficult to come by. Even when space is available, a traditional security solution that focuses on burglary protection often leaves these files unprotected from the threat of fire, which can happen when least expected and can spell disaster, and in some cases, bankruptcy.

Common challenges include:

- **Increased risk of fire:** Every year, thousands of businesses are victims of fire and risk going bankrupt as a result of losing business-critical data or being unable to quantify their insurance claim, which results in withheld or lower-than-expected payouts. As such, a security solution that protects documents against fire can be an important aspect of any disaster recovery plan.
- **Limited certification:** Many filing cabinets on the market today offer certified protection against burglary but the options in certified fire protection are limited. As a result, many companies lack comprehensive protection certified to the most stringent international security standards, which severely compromises the security of paper files in the event of fire.
- **Inadequate storage space:** Traditional cabinets are designed to hold valuable objects as opposed to a large volume of documents. The result is a security solution that lacks organisation, and does not optimise internal space for folders, ring binders, and suspension and box files.
- **Inappropriate storage:** Many "mission-critical" documents within organizations are often held in light steel cabinets offering no protection whatsoever in the events of a fire.

Chubbsafes
Trusted the world over.

Fire resistance to the most stringent international standards

Chubb safes ranges of fire files combine efficient storage with the added benefit of fire protection for paper documents for up to one or two hours. To ensure fire resistance up to the most stringent international standards, each range is subjected to extensive fire testing or combined fire and impact testing, which simulates the impact of a severe fire. This three-step process includes the following:



Step 1

The filing cabinet is placed in a furnace and heated to a temperature of 1000°C or over, depending on the certification level. The furnace is switched off after one or two hours, depending on the certification level. The filing cabinet remains in the furnace until the temperature returns to ambient and is subsequently removed. The content is then examined for signs of damage. Both during furnace heating and the subsequent cooling period, the recorded internal temperature must not have exceeded 177°C (or 350°F).



Step 2

All cabinets are subjected to rapid heating during the explosion or shock test. Cabinets are inserted into a pre-heated furnace to test the strength of construction. During the allotted time duration, internal temperatures are monitored and may not exceed the maximum of 177°C (or 350°F).



Step 3

Some units are also subjected to impact tests. After a subsequent round of furnace heating, the unit is hoisted nearly 10 metres into the air and dropped on a bed of rubble. It is then placed back in the furnace for further heating. At all times, the internal temperature is measured and must never exceed the 150°C limit. Once opened, the contents must show no signs of damage.

Advanced testing for high-level certification

Chubb safes fire files are tested and certified according to the most common and well-established standards:

Underwriter's Laboratories (UL)

UL is a global independent safety science company with more than a century of experience in certifying security products.

All Chubb safes fire files are tested according to UL 72 standard and are certified at Class 350 levels. The Underwriters Laboratory of America, based in Chicago is one of the world's most stringent testing authorities. The UL's classifications are globally recognized and accepted.

The Chubb safes fire files are available in one hour and two hours fire endurance and with or without the additional Impact classification.

A range of fire files to meet your needs and storage requirements

Chubb safes Fire File provides UL 72 Class 350 Endurance certification for up to one or two hours certified by UL.

Models	Certified Fire Rating		Number of drawers
	Up to 1 hour	Up to 2 hours	
Fire File 25"	●	-	2, 4
Fire Files 31"	●	●	2, 3, 4

● Available – Not available

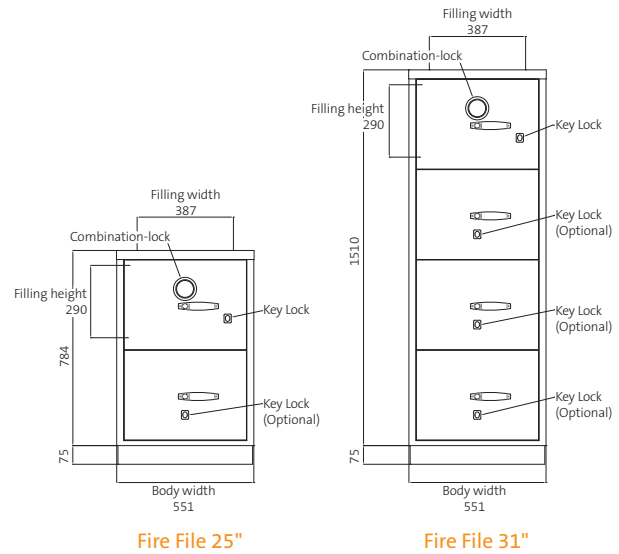
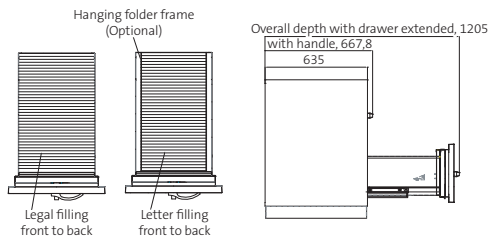

Fire File 25"

Fire File 31"

Dimensions (mm)

Chubb safes Ultra Fire File provides UL 72 Class 350 Endurance & Impact certification for up to one or two hours certified by UL.

Models	Certified Fire Rating		Number of drawers
	Up to 1 hour	Up to 2 hours	
Ultra Fire File 31"	●	●	2, 3, 4

● Available – Not available

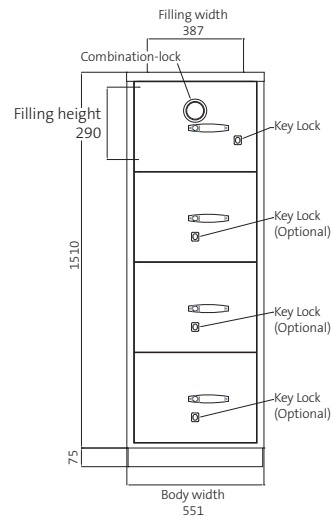

Dimensions (mm)

Chubb safes Binder Fire File provides UL 72 Class 350 Endurance certification for up to two hours certified by UL.

Models	Certified Fire Rating		Number of drawers
	Up to 1 hour	Up to 2 hours	
Binder Fire File	-	●	3, 4

● Available – Not available

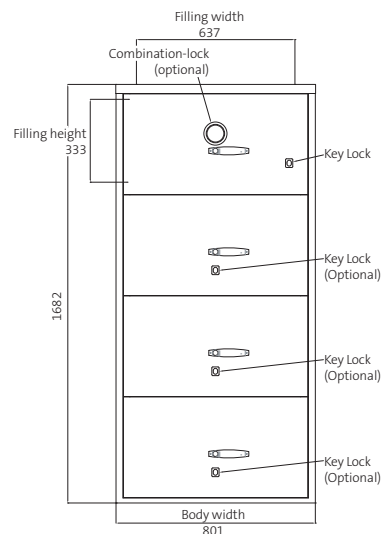
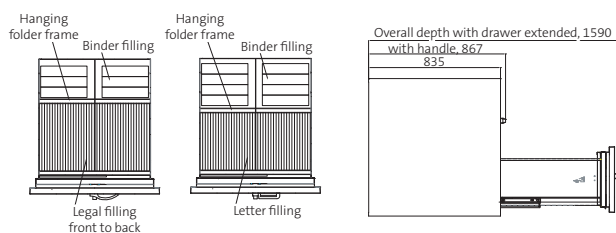

Dimensions (mm)

Chubbsafes Lateral Fire File provides UL 72 Class350 Endurance certification for up to one hour certified by UL.

Models	Certified Fire Rating		Number of drawers
	Up to 1 hour	Up to 2 hours	
Lateral Fire File	●	–	3, 4

● Available – Not available

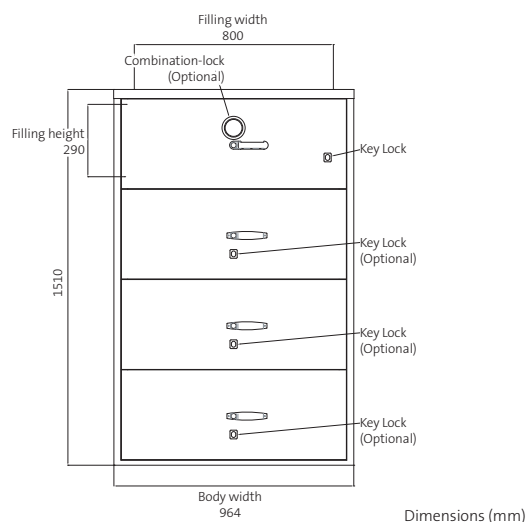
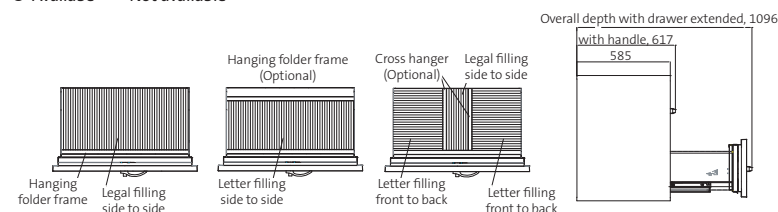

Key Features

Chubbsafes fire files provide the complete filing solution whether business critical documentation is stored in folders, ring binders, suspension files or box files.

- Choice of key or electronic lock, or dual-locking system, either of which is positioned on the top of the drawer and features a push-to-lock function
- Interlocking system that prevents more than 1 drawer from opening at once and eliminates risk of tipping
- Adjustable filing bars to accommodate a wide range of suspension folders
- Simple storage of ring binders and box files for easy access. For example: in the binder file, all four drawers can be used for efficient storage of 33mm binders. Each drawer holds up to 40 A4 DIN 33 mm binders hence 120 and 160 binders in the three and four drawer versions respectively. By comparison, a standard free standing cabinet with five

levels of storage each of 1m length can only hold 150 such binders with difficulties to access shelves on the top. Thus the Chubbsafes binder fire files are the perfect storage solution for the congested offices, allowing users to take full benefit of their storage requirement.

- Perfectly designed for today's modern offices, laterals file sit closer to the wall for marginally more filing than traditional large filing cabinets. They offers exceptional functionality and greater storage capacity.
- Individually isolated drawers to ensure protection even if one drawer remains open in the event of fire (2-hour certified models only)
- A large variety of sizes from 2 to 4 drawers
- Easy operable day-catch locking so that even when unlocked centrally a drawer need only be pushed shut to guarantee the full protection of its content.

Finish

- Color: Light Grey RAL 7035
Stylish and functional, the Chubbsafes fire files blend nicely into any office environment.

Authorised dealer

Chubbsafes
Trusted the world over.

www.chubbsafes.com

'Chubb' is owned by Chubb plc and is a registered trademark used under license